

ARAG NYLON FITTINGS W/ FORK COUPLINGS

Straight Hose Fitting with Female Connector

Code	T	Ø	L	Fork Code
109 0113	T1	13	45	10001
109 0116		16	45	
109 0310	T3	10	48	10003
109 0313		13	48	
109 0316		16	48	
109 0320		20	53	
109 0325		25	53	
109 0413	T4	13	49	10004
109 0416		16	49	
109 0420		20	54	
109 0425		25	54	
109 0430		30	59	
109 0513	T5	13	51	10005
109 0516		16	51	
109 0520		20	56	
109 0525		25	56	
109 0530		30	61	
109 0532		32	61	
109 0535		35	63	
109 0538		38	69	
109 0540	40	69		
109 0625	T6	25	60	10006
109 0630		30	65	
109 0632		32	65	
109 0635		35	67	
109 0638		38	73	
109 0640		40	73	
109 0650		50	81	
109 0740	T7	40	80	10007
109 0745		45	82	
109 0750		50	84	
109 0752		52	84	
109 0760		60	99	
109 0960	T9	60	103	10009
109 0975		75	113	

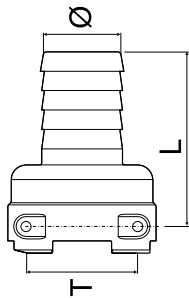

Straight Hose Fitting with Male Connector

Code	T	Ø	L	O-Ring	
				EPDM	Viton
109 1108	T1	8	30	G11056	G11056V
1091110A		10	35		
109 1113A		13	35		
109 1310	T3	10	37	G11058	G11058V
109 1313		13	39		
109 1316		16	39		
109 1320		20	44		
109 1325		25	44		
109 1330		30	48		
109 1413	T4	13	40	G11054	G11054V
109 1416		16	40		
109 1420		20	45		
109 1425		25	45		
109 1430		30	49		
109 1513	T5	13	40	G11063	G11063V
109 1516		16	40		
109 1520		20	45		
109 1525		25	45		
109 1530		30	50		
109 1532		32	50		
109 1535		35	52		
109 1538		38	58		
109 1540	40	58			
109 1625	T6	25	48	G11023	G11023V
109 1630		30	53		
109 1632		32	53		
109 1635		35	55		
109 1638		38	61		
109 1640		40	61		
109 1740	T7	40	62	G11017 x2	G11017V x2
109 1745		45	64		
109 1750		50	69		
109 1752		52	69		
109 1760		60	84		
109 1960	T9	60	86	G11067 x2	G11067V x2
109 1975		75	96		

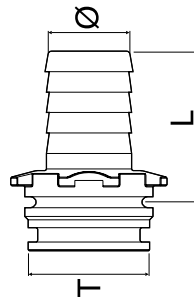

STYLE		TYPE		SIZE		HOSE SIZE		PSI
109	Straight	1	Male	T1	3/8"			290
119	45° or 90°	0	Female	T3	3/4"	10	3/8"	
ARAG Nomenclature								
Example Code: 109 1310								
• 109 = Straight								
• 1 = Male								
• T3 = 3/4"								
• 10 = 3/8" Hose								
				T4	1"	13	1/2"	220
				T5	1 1/4"	20	3/4"	
				T6	1 1/2"	25	1"	180
				T7	2"	32	1 1/4"	120
				T9	3"			70



ARAG NYLON FITTINGS W/ FORK COUPLINGS

90° Hose Fitting w/ Female Connector

Code	T	Ø	A	B	Fork Code
119 0310	T3	10	34	35	10003
119 0313		13	34	45	
119 0316		16	34	48	
119 0320		20	34	53	
119 0325		25	43	53	
119 0413	T4	13	35	45	10004
119 0416		16	35	48	
119 0420		20	35	53	
119 0425		25	44	53	
119 0430		30	45	60	
119 0513	T5	13	37	45	10005
119 0516		16	37	48	
119 0520		20	37	53	
119 0525		25	50	57	
119 0530		30	50	74	
119 0532		32	50	74	
119 0535		35	55	80	
119 0538		38	55	85	
119 0540		40	55	85	
119 0625	T6	25	54	57	10006
119 0630		30	54	74	
119 0632		32	54	74	
119 0635		35	59	80	
119 0638		38	59	85	
119 0640		40	59	85	
119 0740	T7	40	63	85	10007
119 0745		45	69	83	
119 0750		50	84	92	
119 0752		52	84	92	
119 0760		60	99	120	
119 0960	T9	60	102	120	10009
119 0975		75	102	125	

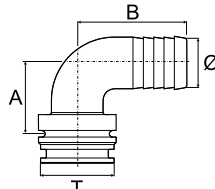
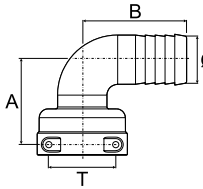

90° Hose Fitting with Male Connector

Code	T	Ø	A	B	O-Ring	
					EPDM	Viton
119 1310	T3	10	25	35	G11058	G11058V
119 1313		13	25	45		
119 1316		16	25	48		
119 1320		20	25	53		
119 1325		25	34	53		
119 1413	T4	13	25	45	G11054	G11054V
119 1416		16	25	48		
119 1420		20	25	53		
119 1425		25	34	53		
119 1430		30	35	60		
119 1513	T5	13	26	45	G11063	G11063V
119 1516		16	26	48		
119 1520		20	26	53		
119 1525		25	39	57		
119 1530		30	39	74		
119 1532		32	39	74		
119 1535		35	44	80		
119 1538		38	44	85		
119 1540		40	44	85		
119 1625	T6	25	42	57	G11023	G11023V
119 1630		30	42	74		
119 1632		32	42	74		
119 1635		35	47	80		
119 1638		38	47	85		
119 1640		40	47	85		
119 1740	T7	40	48	85	G11017 x2	G11017V x2
119 1745		45	54	83		
119 1750		50	59	92		
119 1752		52	59	92		
119 1760		60	79	120		
119 1960	T9	60	84	120	G11067 x2	G11067V x2
119 1975		75	84	125		

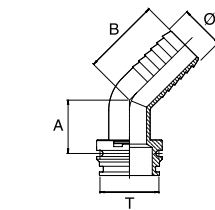

45° Hose Fitting with Female Connector

Code	T	Ø	A	B	Fork Code
119 2430	T4	30	47	55	10004
119 2525	T5	25	50	50	10005
119 2530		30	50	55	
119 2630	T6	30	54	55	10006
119 2635		35	54	55	
119 2640		40	54	60	
119 2750	T7	50	60	70	10007

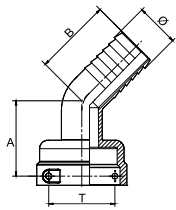

45° Hose Fitting with Male Connector

Code	T	Ø	A	B	O-Ring	
					EPDM	Viton
119 3525	T5	25	38	50	G11063	G11063V
119 3530		30	38	55		
119 3535		35	38	55		
119 3630	T6	30	41	55	G11023	G11023V
119 3635		35	41	55		
119 3640		40	41	60		
119 3760	T7	60	37	82	G11017 x2	G11017V x2



ARAG NYLON FITTINGS W/ FORK COUPLINGS

Male Threaded with Female Connection

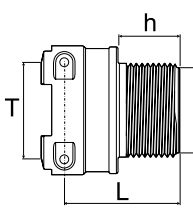

Code	T	F	L mm	h mm	Fork Code
249 033	T3	G ¾ M	40	22	10003
249 044	T4	G 1 M	41	22	10004
249 055	T5	G 1 ¼ M	46	24	10005
249 064	T6	G 1 M	46	22	10006
249 065		G 1 ¼ M	48	24	
249 066		G 1 ½ M	49	24	
249 067		G 2 M	47	27	
249 074	T7	G 1 M	51	22	10007
249 075		G 1 ¼ M	53	24	
249 076		G 1 ½ M	53	24	
249 077		G 2 M	59	27	

Male/ Male Nipple

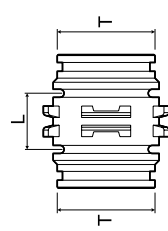

Code	T	L mm	O-Ring	
			EPDM	Viton
259 133	T3	17	G11058	G11058V
259 144	T4	19	G11054	G11054V
259 155	T5	20	G11063	G11063V
259 166	T6	28	G11023	G11023V
259 177	T7	28	G11017 x2	G11017V x2
259 199	T9	31	G11067 x2	G11067V x2

Female/ Female Coupling

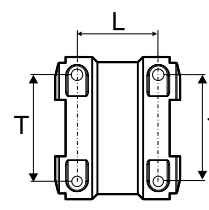

Code	T	L mm	Fork Code
259 033	T3	27	10003
259 044	T4	30	10004
259 055	T5	32	10005
259 066	T6	41	10006
259 077	T7	47	10007
259 099	T9	54	10009

Male Threaded with Male Connection

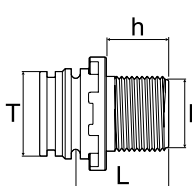

Code	T	F	L mm	h mm	O-Ring	
					EPDM	Viton
249 133	T3	G ¾ M	33	22	G11058	G11058V
249 144	T4	G 1 M	33	22	G11054	G11054V
249 155	T5	G 1 ¼ M	37	24	G11063	G11063V
249 166	T6	G 1 ½ M	42	24	G11023	G11023V
249 177	T7	G 2 M	45	27	G11017 x2	G11017V x2
249 199	T9	G 3 M	54	35	G11067 x2	G11067V x2

Bulkhead Male Threaded with Male Connection

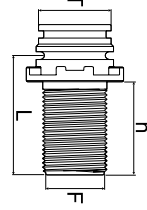

Code	T	F	O-Ring	
			EPDM	Viton
249 1551	T5	G 1 ¼ M	G11063	G11063V
249 1661	T6	G 1 ½ M	G11023	G11023V
249 1771	T7	G 2	G11017 x2	G11017V x2

45° Fittings with Female/Male Fork Connection

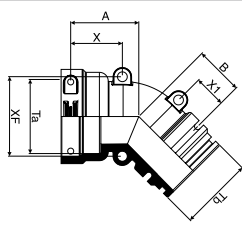

Code	Ta	a Fork	Tb	O-Ring b		X mm	X1 mm	A mm	B mm	XF mm
				EPDM	Viton					
129 555	T5	10005	T5	G11063	G11063V	31	20	41	30	48
129 566	T6	10006	T6	G11023	G11023V	35	22	46	33	54
129 577	T7	10007	T7	G11017 x2	G11017V x2	39	24	53	37	65
129 599	T9	10009	T9	G11067 x2	G11067V x2	44	25	64	45	95

45° Fittings Male Threaded with Female Fork Connection

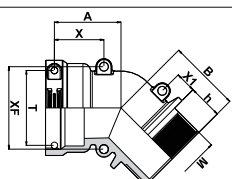

Code	T	M (BSP)	h mm	X mm	X1 mm	A mm	B mm	XF mm	a Fork Code
119 27B7	T7	G2	27	39	16.5	52.5	57	65	10007

45° Fitting with Female/Female Fork Connection

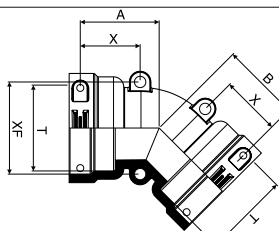

Code	T	X mm	A mm	B mm	XF mm	Fork Code
129 355	T5	31	41	41	48	10005
129 366	T6	35	46	46	54	10006
129 377	T7	39	53	53	65	10007
129 399	T9	44	64	64	95	10009



ARAG NYLON FITTINGS W/ FORK COUPLINGS

Male/Male Adapter

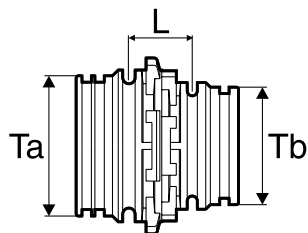

Code	L mm	Ta	O-Ring a		Tb	O-Ring b	
			EPDM	Viton		EPDM	Viton
259 134	18	T4	G11054	G11054V	T3	G11058	G11058V
259 145	19	T5	G11063	G11063V	T4	G11054	G11054V
259 156	23	T6	G11023	G11023V	T5	G11063	G11063V
259 167	27	T7	G11017 x2	G11017V x2	T6	G11023	G11023V
259 179	30	T9	G11067 x2	G11067V x2	T7	G11017 x2	G11017V x2

Flanged Male Adapter

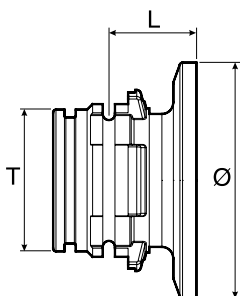

Code	T	O	Type	L mm	O-Ring	
					EPDM	Viton
279 144	T4	1"	----	27	G11054	G11054V
279 154	T5	1"	----	28	G11063	G11063V
279 157		2"	std. port	28		
279 167	T6	2"	std. port	31	G11023	G11023V
279 1671		2"	full port	31		
279 177	T7	2"	std. port	32	G11017 x2	G11017V x2
279 1771		2"	full port	32		

Tightening Clamp with Screw and Seal

Code	Ø
2790 00.100	1" Full port
2790 00.200	2" Std. port
2790 00.220	2" Full port

Compatible with Banjo, Hypro and Bee Valve connection

Female/ Female Adapter

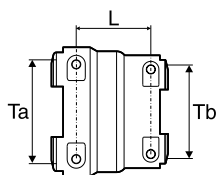

Code	L mm	Ta	Fork Code	Tb	Fork Code
259 034	29	T4	10004	T3	10003
259 045	31	T5	10005	T4	10004
259 056	37	T6	10006	T5	10005
259 067	44	T7	10007	T6	10006

Blanking Cap

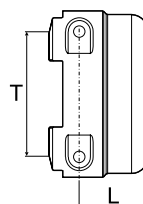

Code	T	L mm	Fork Code	
219 010	T1	14	25	10001
219 030	T3	18	25	10003
219 040	T4	19	25	10004
219 050	T5	21	10	10005
219 060	T6	24	10	10006
219 070	T7	29	10	10007
219 090	T9	33	10	10009

Camlock Adapter with Female Connection

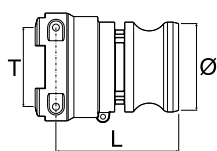

Code	T	Ø	L mm	Fork Code
181 06L	T6	1" ½	80	10006
181 07L	T7	2"	88	10007
181 09L	T9	3"	100	10009

Female/ Male Adapter

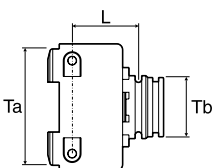

Code	L mm	Ta	a Fork	Tb	O-Ring b	
					EPDM	Viton
259 263	34	T6	10006	T3	G11058	G11058V
259 267	40			T7	G11017 x2	G11017V x2

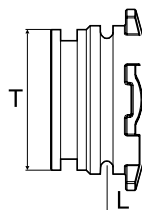

Code	T	L mm	O-Ring	
			EPDM	Viton
219 130	T3	9	G11058	G11058V
219 140	T4	10	G11054	G11054V
219 150	T5	10	G11063	G11063V
219 160	T6	13	G11023	G11023V
219 170	T7	14	G11017 x2	G11017V x2
219 190	T9	16	G11067 X2	G11067V X2



ARAG NYLON FITTINGS W/ FORK COUPLINGS

90° Female/Female Elbow

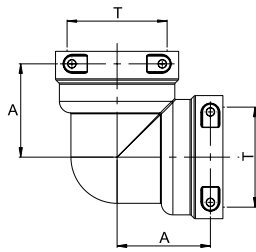

Code	T	A mm	Fork Code
129 033	T3	32	10003
129 044	T4	36	10004
129 055	T5	41	10005
129 066	T6	49	10006
129 077	T7	57	10007
129 099	T9	75	10009

90° 4-Way Fitting with Female Connector

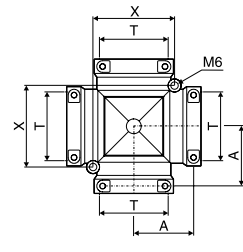

Code	T	A mm	X mm	Fork Code
159 033	T3	32	44	10003
159 055	T5	41	59	10005
159 066	T6	49	67	10006
159 077	T7	57	77	10007
159 099	T9	75	108	10009

90° Female/Male Elbow

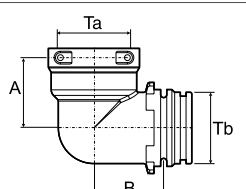

Code	A mm	B mm	Ta	a Fork Code	Tb	b O-Ring	
						EPDM	Viton
129 266	54	49	T6	10006	T6	G11023	G11023V
129 277	57	52	T7	10007	T7	G11017 x2	G11017V x2

3-Way Manifold

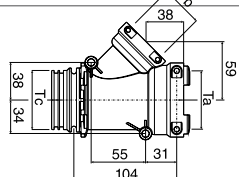

Code	Ta	a Fork	Tb	b Fork	Tc	b O-Ring	
						EPDM	Viton
179 275	T7	10007	T5	10005	T7	G11017 x2	G11017V x2

Tee Fitting with Female Connection

ARAG T-Shaped fittings with fork couplings can be fixed to a surface by means of two hexagonal-head screws to be fitted in the slots located on fittings upper side.

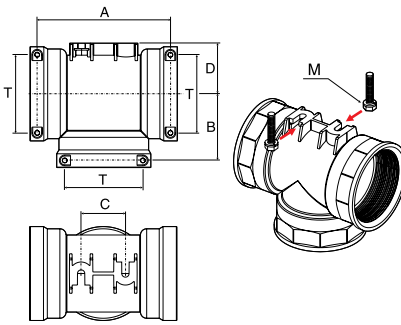

Code	T	A (mm)	B (mm)	C (mm)	D (mm)	M	Fork Code
139 033	T3	63	32	14	25	M5	10003
139 044	T4	71	36	14	27	M5	10004
139 055	T5	81	41	16	32	M6	10005
139 066	T6	97	49	24	35	M6	10006
139 077	T7	113	57	32	41	M6	10007
139 099	T9	150	75	50	57	M8	10009

Tee Fitting with Male Connection

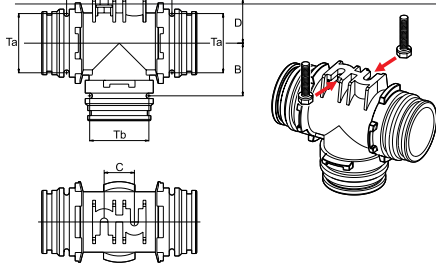

Code	A (mm)	B (mm)	C (mm)	D (mm)	Ta	a O-Ring		Tb	b O-Ring	
						EPDM	Viton		EPDM	Viton
139 165	84	38	24	35	T6	G11023	G11023V	T5	G11063	G11063V
139 166	84	42	24	35	T6	G11023	G11023V	T6	G11023	G11023V

STYLE		TYPE		SIZE		HOSE SIZE	
109	Straight	1	Male	T3	3/4"	10	3/8"
119	45° or 90°	0	Female	T4	1"	13	1/2"
				T5	1 1/4"	20	3/4"
				T6	1 1/2"	25	1"
				T7	2"	32	1 1/4"
				T9	3"		

ARAG Nomenclature Example Code: 109 1310

- 109 = Straight
- 1 = Male
- T3 = 3/4"
- 10 = 3/8" Hose



POLYPROPYLENE FITTINGS

Bushing Reducing MPT x FPT				Elbow Street, FPTx MPT			
Banjo Part No.	Part No.	Male Thread (in)	Female Thread (in)	Banjo Part No.	Part No.	Female Thread (in)	Male Thread (in)
N/A	PF-RB3818	3/8	1/8	TP-SL02590	PF-SE14	1/4	1/4
TP-RB038025	PF-RB3814	3/8	1/4	TP-SL05090	PF-SE12	1/2	1/2
TP-RB050018	PF-RB1218	1/2	1/8	TP-SL07590	PF-SE34	3/4	3/4
TP-RB050025	PF-RB1214	1/2	1/4	TP-SL10090	PF-SE100	1	1
TP-RB050038	PF-RB1238	1/2	3/8	TP-SL12590	PF-SE114	1-1/4	1-1/4
TP-RB075018	PF-RB3418	3/4	1/8	TP-SL15090	PF-SE112	1-1/2	1-1/2
TP-RB075025	PF-RB3414	3/4	1/4	TP-SL20090	PF-SE200	2	2
TP-RB075038	PF-RB3438	3/4	3/8	Elbow, HB x HB			
TP-RB075050	PF-RB3412	3/4	1/2	Banjo Part No.	Part No.	Hose Barb (in)	Hose Barb (in)
TP-RB100050	PF-RB10012	1	1/2	N/A	PF-EB1414	1/4	1/4
TP-RB100075	PF-RB10034	1	3/4	N/A	PF-EB3814	3/8	1/4
TP-RB125075	PF-RB11434	1-1/4	3/4	N/A	PF-EB3838	3/8	3/8
TP-RB125100	PF-RB114100	1-1/4	1	N/A	PF-EB1214	1/2	1/4
TP-RB150075	PF-RB11234	1-1/2	3/4	N/A	PF-EB1238	1/2	3/8
TP-RB150100	PF-RB112100	1-1/2	1	N/A	PF-EB1212	1/2	1/2
TP-RB150125	PF-RB112114	1-1/2	1-1/4	N/A	PF-EB5858	5/8	5/8
TP-RB200075	PF-RB20034	2	3/4	N/A	PF-B3458	3/4	5/8
TP-RB200100	PF-RB200100	2	1	N/A	PF-EB3434	3/4	3/4
TP-RB200125	PF-RB200114	2	1-1/4	TP-HBEL10090	PF-EB1010	1	1
TP-RB200150	PF-RB200112	2	1-1/2	N/A	PF-EB114	1-1/4	1-1/4
TP-RB300200	PF-RB300200	3	2	N/A	PF-EB112	1-1/2	1-1/2
Coupling, FPT x FPT				N/A	PF-EB200	2	2
Banjo Part No.	Part No.	Female Thread (in)	Female Thread (in)	Hose Mender HB x HB			
TP-CPLG050	PF-FC12	1/2	1/2	Banjo Part No.	Part No.	Hose Barb (in)	Hose Barb (in)
TP-CPLG075	PF-FC34	3/4	3/4	TP-HM025	PF-SHM14	1/4	1/4
TP-CPLG100	PF-FC100	1	1	TP-HM038	PF-SHM38	3/8	3/8
TP-CPLG125	PF-FC114	1-1/4	1-1/4	TP-HM050	PF-SHM12	1/2	1/2
TP-CPLG150	PF-FC112	1-1/2	1-1/2	N/A	PF-SHM1238	1/2	3/8
TP-CPLG200	PF-FC200	2	2	N/A	PF-SHM1258	1/2	5/8
Elbows, FPT x FPT				N/A	PF-SHM58	5/8	5/8
Banjo Part No.	Part No.	Female Thread (in)	Female Thread (in)	TP-HM075	PF-SHM34	3/4	3/4
TP-EL05090	PF-LL12	1/2	1/2	TP-HM100	PF-SHM100	1	1
TP-EL07590	PF-LL34	3/4	3/4	TP-HM125	PF-SHM114	1-1/4	1-1/4
TP-EL10090	PF-LL100	1	1	TP-HM150	PF-SHM112	1-1/2	1-1/2
TP-EL12590	PF-LL114	1-1/4	1-1/4	TP-HM200	PF-SHM200	2	2



POLYPROPYLENE FITTINGS



Elbow, MPT x HB

Banjo Part No.	Part No.	Male Thread (in)	Hose Barb (in)
N/A	PF-EL1838	1/8	3/8
TP-HB02590	PF-EL14	1/4	1/4
TP-HB02503890	PF-EL1438	1/4	3/8
TP-HB02505090	PF-EL1412	1/4	1/2
N/A	PF-EL1458	1/4	5/8
N/A	PF-EL1814	1/8	1/4
N/A	PF-EL3814	3/8	1/4
N/A	PF-EL38	3/8	3/8
TP-HB03805090	PF-EL3812	3/8	1/2
TP-HB05002590	PF-EL1214	1/2	1/4
TP-HB05003890	PF-EL1238	1/2	3/8
TP-HB05090	PF-EL12	1/2	1/2
N/A	PF-EL1258	1/2	5/8
TP-HB05007590	PF-EL1234	1/2	3/4
N/A	PF-EL12100	1/2	1
N/A	PF-EL3414	3/4	1/4
N/A	PF-EL3438	3/4	3/8
TP-HB07505090	PF-EL3412	3/4	1/2
N/A	PF-EL3458	3/4	5/8
TP-HB07590	PF-EL34	3/4	3/4
TP-HB07510090	PF-EL34100	3/4	1
TP-HB10005090	PF-EL10012	1	1/2
TP-HB10007590	PF-EL10034	1	3/4
TP-HB10090	PF-EL100	1	1
TP-HB12507590	PF-EL11434	1-1/4	3/4
TP-HB12510090	PF-EL114100	1-1/4	1
TP-HB12590	PF-EL114	1-1/4	1-1-4
TP-HB12515090	PF-EL114112	1-1/4	1-1/2
TP-HB15090	PF-EL112	1-1/2	1-1/2
TP-HB20090	PF-EL200	2	2

Hose Barb x MPT

Banjo Part No.	Part No.	Male Thread (in)	Hose Barb (in)
-	PF-A1814	1/8	1/4
-	PF-A1838	1/8	3/8
TP-HB025	PF-A140	1/4	1/4
TP-HB025038	PF-A1438	1/4	3/4
TP-HB025050	PF-A1412	1/4	1/2
TP-HB038025	PF-A3814	3/8	1/4
TP-HB038	PF-A380	3/8	3/8
TP-HB038050	PF-A3812	3/8	1/2
TP-HB050025	PF-A1214	1/2	1/4
TP-HB050038	PF-A1238	1/2	3/8
TP-HB050	PF-A120	1/2	1/2
N/A	PF-A1258	1/2	5/8
TP-HB050075	PF-A1234	1/2	3/4
N/A	PF-A12100	1/2	1
N/A	PF-A3414	3/4	1/4
TP-HB075038	PF-A3438	3/4	3/8
TP-HB075050	PF-A3412	3/4	1/2
TP-HB075058	PF-A3458	3/4	5/8
TP-HB075	PF-A340	3/4	3/4
TP-HB075100	PF-A34100	3/4	1
TP-HB100075	PF-A10034	1	3/4
TP-HB100	PF-A100	1	1
TP-HB100125	PF-A100114	1	1-1/4
TP-HB125075	PF-A11434	1-1/4	3/4
TP-HB125100	PF-A114100	1-1/4	1
TP-HB12525	PF-A114	1-1/4	1-1/4
TP-HB125150	PF-A114112	1-1/4	1-1/2
TP-HB150125	PF-A112114	1-1/2	1-1/4
TP-HB150	PF-A112	1-1/2	1-1/2
TP-HB200	PF-A200	2	2

Ball Check Valve

Part No.	Pipe Thread (in)	PSI
PF-NBC10	1 1/16 M X 1 1/16 F	10

If you do not see a fitting or size that you need, please call a NCI representative for further assistance. Fittings shown in catalog are the most commonly sold.



POLYPROPYLENE FITTINGS

Nipples MPT x MPT				
Banjo Part No.	Part No.	Male Pipe Thread (in)	Male Pipe Thread (in)	
TP-NIP025SH	PF-M1400	¼	¼	
TP-NIP038SH	PF-M3800	⅜	⅜	
TP-RN050038	PF-M3812	⅜	½	
TP-NIP050SH	PF-M1200	½	½	
N/A	PF-M1214	½	¼	
TP-NIP075SH	PF-M3400	¾	¾	
N/A	PF-M3438	¾	⅝	
TP-RN075050	PF-M3412	¾	½	
TP-NIP100SH	PF-M1000	1	1	
TP-NIP124SH	PF-M1140	1-¼	1-¼	
TP-NIP150SH	PF-M1120	1-½	1-½	
TP-NIP200SH	PF-M2000	2	2	



Tee, HB x HB x HB				
Banjo Part No.	Part No.	Hose Barb (in)	Hose Barb (in)	Hose Barb (in)
N/A	PF-T18	⅛	⅛	⅛
TP-HBT025	PF-T14	¼	¼	¼
TP-HBT038	PF-T38	⅜	⅜	⅜
TP-HBT050038	PF-T3812	⅜	⅜	⅜
N/A	PF-T1238	½	½	½
TP-HBT050	PF-T12	½	½	½
N/A	PF-T58	⅝	⅝	⅝
TP-HBT075050	PF-T3412	¾	¾	¾
TP-HBT075	PF-T34	¾	¾	¾
TP-HBT100	PF-T100	1	1	1
N/A	PF-T114	1-¼	1-¼	1-¼
N/A	PF-T112	1-½	1-½	1-½
TP-HBT200	PF-T200	2	2	2

Plug, MPT		
Banjo Part No.	Part No.	Male Thread (in)
N/A	PF-F1800	⅛
TP-PLUG025	PF-F1400	¼
TP-PLUG038	PF-F3800	⅜
TP-PLUG050	PF-F1200	½
TP-PLUG075	PF-F3400	¾
TP-PLUG100	PF-F1000	1
TP-PLUG125	PF-F1014	1-¼
TP-PLUG150	PF-F112	1-½
TP-PLUG200	PF-F200	2



Banjo Manifold Poly Fittings

Flange x Flange 90°		
Part No.	Flange (in)	Flange (in)
M100CPG90	1	1
M200CPG90	2	2
M200CPG90SH	2 Std.	2 Std.
M220CPG90	2 Full	2 Full
M300CPG90	3	3
M200CPG45	2	2" 45°



Tee, FPT x FPT x FPT x GP						
Banjo Part No.	Part No.	Female Thread (in)	Female Thread (in)	Female Thread (in)	Gauge Port (in)	
N/A	PF-GTT1214	½	½	½	½	
TP-TEG075	PF-GTT3414	¾	¾	¾	¾	

Flange x Barb, 90° Elbow		
Part No.	Flange (in)	Barb (in)
M10075BRB90	1	¾
M100BRB90	1	1
M100125BRB90	1	1-¼
M200100BRB90	2 Std.	1
M200125BRB90	2 Std.	1-¼
M200150BRB90	2 Std.	1-½
M200BRB90	2 Std.	2
M220150BRB90	2 Full	1-½
M220BRB90	2 Full	2
M300220BRB90	3	2
M300BRB90	3	3



Tee, FPT x FPT x FPT				
Banjo Part No.	Part No.	Female Thread (in)	Female Thread (in)	Female Thread (in)
TP-TEE025	PF-TT14	¼	¼	¼
TP-TEE050	PF-TT12	½	½	½
TP-TEE075	PF-TT34	¾	¾	¾
TP-TEE100	PF-TT100	1	1	1
TP-TEE125	PF-TT114	1-¼	1-¼	1-¼
TP-TEE150	PF-TT112	1-½	1-½	1-½
TP-TEE200	PF-TT200	2	2	2



If you do not see a fitting or size that you need, please call a NCI representative for further assistance. Fittings shown in catalog are the most commonly sold. Others are available.



BANJO MANIFOLD POLYPROPYLENE FITTINGS

Clamps & Accessories		Connect, Flange x Female Pipe Thread		
	Banjo Part No.	Description		
	TP-FC100	1" Worm Screw Clamp		
	TP-FC200	2" Std. Worm Screw Clamp		
	TP-FC220	2" Full Worm Screw Clamp		
	TP-FC300	3" Worm Screw Clamp		
	TP-M100G	1" EDPM Gasket		
	TP-M100GV	1" Viton Gasket		
	TP-150G	2" Std. EPGM Gasket		
	TP-150GV	2" Std. Viton Gasket		
	TP-200G	2" Full EPGM Gasket		
	TP-200GV	2" Full Viton Gasket		
	TP-300G	3" EPGM Gasket		
	TP-300GV	3" Viton Gasket		
	TP-UB100	1" Mounting U-Bolt, SS		
	TP-UB200	2" Std. Mounting U-Bolt, SS		
	Coupling, 45°			
	Part No.	Flange		
	TP-M100CPG45	1" Flange		
	TP-M200CPG45	2" Std. Port		
	Couplings, Flange			
	Part No.	Flange (in)		
	TP-M100CPG	1 x 1		
	TP-M200CPG	2 x 2 Std.		
	Reducing Coupling, Flange			
	Part No.	Flange	Reducer (in)	
	TP-M200100CPG	2" Std.	1	
	TP-M220100CPG	2" Full	1	
	TP-M220200CPG	2" Full	2 Std.	
	Connect, Male Thread x Flange			
	Part No.	Flange (in)	Male Thread (in)	
	TP-M100075MPT	1	¾	
	TP-M100MPT	1	1	
	TP-M100125MPT	1	1-¼	
	TP-M200125MPT	2 Std.	1-¼	
	TP-M200150MPT	2 Std.	1-½	
	TP-M200MPT	2 Std.	2	
	TP-M220MPT	2 Full	2	
	TP-M300MPT	3	3	
	Connect, Flange x Female Pipe Thread			
	Part No.	Flange (in)	Thread (in)	
	TP-M100050FPT	1	½	
	TP-M100075FPT	1	¾	
	TP-M100FPT	1	1	
	Flange x Barb			
	Part No.	Flange (in)	Barb (in)	
	TP-M100075BRB	1	¾	
	TP-M100BRB	1	1	
	TP-M100125BRB	1	1-¼	
	TP-M200100BRB	2 Std.	1	
	TP-M200150BRB	2 Std.	1-¼	
	TPM200125BRB	2 Std.	1-½	
	TP-M200BRB	2 Std.	2	
	TP-M220150BRB	2 Full	1-½	
	TP-M220BRB	2 Full	2	
	TP-M300220BRB	3	2	
	TP-M300BRB	3	3	
		Flange x Male Adapter		
Part No.		Adapter (in)	Flange (in)	
TP-M220A		2	2	
	TP-M300A	3	3	
	Cross, Flange			
	Part No.	Description		
	TP-M100CR	1" Flange Cross		
	TP-M200CR	2" Std. Port Flange Cross		
	TP-M220CR	2" Full Port Flanged Cross		
	TP-M300CR	3" Flanged Cross		
	Tee			
	Part No.	Description		
	TP-M100TEE	1" Flange Tee		
	TP-M101TEE	1" Flange Tee, Long		
	TP-M200100TEE	2" Std. Port x 1" Flange Tee		
	TP-M200TEE	2" Std Port Flange Tee		
	TP-M220TEE	2" Full Port Flange Tee		
	TP-M300TEE	3" Flange Tee		
	Flange with Inductor			
	Part No.	Description		
	TP-M200TEEV075	2" Std. Flange Tee with ¾" Inductor		
	TP-M100075BRBV	1" Flange x Smooth ¾" Barb		





HOSE & TUBING - ORDER BY THE FOOT

Wire Reinforced EPDM Suction/ Discharge Hose <ul style="list-style-type: none"> Wire helix with textile ply wrapped with smooth cover Safe for variety of liquid requiring elevated pressure Sold by the foot. Specify length when ordering 	Part No.	ID (in)	PVC Bumble Bee HD Suction Hose <ul style="list-style-type: none"> Used on NCI Liquid Equipment Flexible with good adhesion between soft wall and helix Safe for water & light chemical solutions Ridged exterior, not transparent 	Part No.	ID (in)
	HO-SH114EPDM	1-1/4		HO-SHBB100	1
	HO-SH112EPDM	1-1/2		HO-SHBB114	1-1/4
	HO-SH200EPDM	2		HO-SHBB112	1-1/2
	HO-SH300EPDM	3		HO-SHBB200	2
EVA Tubing <ul style="list-style-type: none"> Semi-translucent tubing made of ethyl vinyl acetate Ideal for herbicide, pesticide, anhydrous ammonia applicator hose; vacuum hose, sight gauge 	Part No.	ID (in)	Ag Spray Hose <ul style="list-style-type: none"> Safe for water discharge in residential, agricultural, and industrial applications NCI commonly stocks 1/2", 3/4", 1-1/2", 2" 3/4" Hose used on NCI liquid equipment between nozzles 2" hose used on NCI liquid equipment on to protect booms 	1/2" Hose Part No.	PSI
	HO-12EVA	1/2"		HO-12150	150PSI
	HO-34EVA	3/4"		HO-12300	300 PSI
	HO-38EVA	3/8"		HO-12600	600 PSI
Clear Vinyl Tubing <ul style="list-style-type: none"> High gloss clear tubing made of non-toxic crystal PVC Ideal for water, weak chemicals and acids, sight gauge, drainage, air lines NSF-51 and NSF-61 certified material 	Part No.	ID (in)		HO-12800	800 PSI
	HO-CT14PVC	1/4		3/4" Hose Part No.	PSI
	HO-CT38PVC	3/8, 1/16" wall		HO-34150	150 PSI
	HO-CT38PVCTW	3/8, 1/8" wall		HO-34200	200 PSI
	HO-CT12PVC	1/2, 1/16" wall		HO-34300	300 PSI
	HO-CT12PVCTW	1/2, 1/8" wall		HO-34600	600 PSI
	HO-CT58PVC	5/8		HO-34800	800 PSI
	HO-CT34PVC	3/4		1-1/2" Hose Part No.	PSI
	HO-CT100PVC	1	HO-122150	150	
	HO-CT112PVC	1-1/2	2" Hose Part No.	PSI	
Nylon Air Line Tubing Unbraided: <ul style="list-style-type: none"> Ideal for pneumatic lines, instrumentation systems, lubrication, fuel, oil, and refrigerant line Braided: <ul style="list-style-type: none"> Ideal for material handling, water, light chemical solutions 	Unbraided Part No.	ID (in)	HO-200150	150	
	DF-KO348	1/4	Reinforced Fertilizer Solution Hose	Part No.	ID x OD
	Braided 1/16" wall Part No.	ID (in)	HO-SH114FERT	1 1/4" x 1.6"	
			HO-SH112FERT	1 1/2" x 1.86"	
HO-CT38BPVC	3/8	HO-SH200FERT	2" x 2.66"		
HO-CT12BPVC	1/2	HO-SH300FERT	3" x 3.86"		
PVC Lay Flat Discharge Hose <ul style="list-style-type: none"> Used as a protective barrier for other hoses on NCI Equipment Resistant to abrasion and aging Safe for water discharge 	Part No.	ID (in)	Hydraulic Hose <ul style="list-style-type: none"> Variety of sizes used on NCI dry equipment 1/2" commonly used on NCI liquid equipment 	Part No.	ID (in)
	HO-200065PVC	2		HH-HFS204	1/4
	HO-30065PVC	3		HH-HFS208	1/2
PVC Standard Duty Suction Hose <ul style="list-style-type: none"> Previously used on NCI liquid equipment; now use PVC Bumble Bee because of ease of use Flexible with good adhesion between soft wall and helix Safe for water & light chemical solutions Clear, smooth surfaces 	Part No.	ID (in)		HH-HFS212	3/4
	HO-SH34PVC	3/4	HH-HFS216	1	
	HO-SH100PVC	1	HH-HFS220	1 1/4	
	HO-SH114PVC	1-1/4			
	HO-SH112PVC	1-1/2			
	HO-SH200PVC	2			
	HO-SH300PVC	3			
HO-SH400PVC	4				



CLAMPS & HOSE REEL

T Bolt Hose Clamp • Stainless steel bolt with silver plated nut to prevent seizing • 360 degree sealing surface • Ideal for high torque applications • Many other sizes available 	Part No.	ID (in)	Diameter Range (in)	Clamp • Stainless steel housing 	Part No.	ID (in)			
					TP-TC218	2	2.18-2.5	CL-0400	¼
					TP-TC331	3	3.31-3.62	CL-0600	¾
					TP-TC343	3	3.43-3.75	CL-0800	½
					CL-1200	¾			
					CL-1600	1			
					CL-3200	2			
					CL-4000	2-½			

Please call NCI Parts for further information



HOSE REEL



- Titan Models 4312H, 4318H, 4312E, 4318E**
- Heavy duty aluminum frame
 - Super swivel with ball bearing support and grease fitting
 - Aluminum Disks. PVC spool. Plated steel hardware. Carbon steel manifold
 - 2- vane semi open impeller
 - Spring loaded pin-lock - 4312H, 4318H
 - Switch and solenoid are mounted on a SS plate and wired to 12 volt electric motor - 4312E, 4318E

- Titan Model 3012**
- Economical steel reel
 - Black powder coated
 - Dimensionally identical to 4312H

- Summit Features**
- ½" or 1" inlet/outlet available
 - Capacity up to 650' of ¾" hose
 - All reels pressure treated, power coated

SM Series

- Steel crank handle with free turning hand grip

SME Series

- ⅓ HP 12 volt DC motor
- Pre-wired heavy duty push button switch
- Solenoid included & Mounted

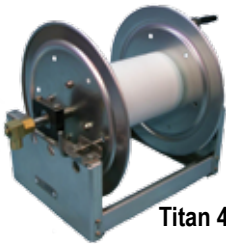

Titan 4312H



Titan 4312E with optional hose guide



Titan 3012



Summit SM Series

Full Frame Part No.	Electric Rewind Part No.	Hose ID in Inches					Inlet/Outlet NPT	Spool Width (in)	Spool Dia. (in)
		¼	¾	½	⅝	1			
Titan Hose Reels									
4312H	4312E	425	300	200	150	--	½	12	6
4318H	4318E	625	450	325	225	--	½	18	6
3012	-	425	300	200	150	-	½	12	6
Summit Hose Reels									
HR-SM12	-	400	250	175	100	70	½ or 1	12	6
HR-SM60	-	175	100	75	40	--	½ or 1	6	6
HR-SM80	-	200	140	100	60	--	½ or 1	8	6
-	HR-SME18	600	400	300	150	125	½ or 1	18	6
Length of Hose in Feet									

